

Enclosed three-phase asynchronous motors driven by electronic drive LSMV



General information



Enclosed 3-phase asynchronous motors, LSMV series, according to IEC 60034, 60072. LSMV motor is the result of Leroy-Somer's experience with speed variation and progress in performance of new electronic controllers.

- Power from 0.25 to 132 kW, frame size from 71 to 315 mm, 2, 4 and 6 poles. Three-phase supply 380/415 V, IP 55 protection.

LSMV is at the base of a large motor range for speed variation.

Leroy-Somer can also provide FLSES motors with cast iron housing, motors with reinforced mechanical protection and PLSES motors with aluminium housing and IP 23 protection.

The association of MV range motors and of DIGIDRIVE, PROXIDRIVE or UNIDRIVE SP electronic controllers, gives the user the **guarantee of performances** in torque and speed.

Description of LSMV three-phase motors

Component	Material	Remarks
Finned housing	Aluminium alloy	<ul style="list-style-type: none"> - with bolt-on or cast foot, or without foot - pressure die casting for frame size ≤ 180 - gravity casting for frame size ≥ 200 <ul style="list-style-type: none"> • 4 or 6 mounting holes for the foot housings • lifting rings frame size ≥ 100 - earth terminal with an optional jumper screw
Stator	Insulated magnetic cover with low carbon rate Electrolytic copper	<ul style="list-style-type: none"> - the low carbon content guarantees long term stability of the characteristics - semi-enclosed slots - magnetic circuit which is based on experience acquired in frequency variation - impregnation allowing resistance to violent voltage variations determined by high switching frequencies of IGBT transistor drives in accordance to IEC 34-17 - insulation system class F - thermal protection provided by 3 probes CTP (1 per phase)
Rotor	Insulated magnetic cover with low carbon rate Aluminium	<ul style="list-style-type: none"> - inclined slots - squirrel cage pressure die cast in aluminium (or alloy for special applications) - mounted on the shaft by heat shrinking and keyed for hoisting applications - dynamically balanced rotor class B for frame size ≤ 132
Shaft	Steel	
Flange bearings	Cast iron	- frame size from 80 to 315
Bearings and lubrication		<ul style="list-style-type: none"> - ball bearings lubricated for life for frame size from 71 to 225 - ball bearings regreasable for frame size from 250 to 315 - rear preloaded bearings
Labyrinth seals Lipseals	Technopolymer or steel Synthetic rubber	<ul style="list-style-type: none"> - seal or front deflector for all flanged motors - seal, deflector or heat seal for feet motors
Fan	Composite material	- 2 directions of rotation: straight blades
Fan cover	Sheet steel	- on request, fitted with a drip cover for operation in vertical position, shaft facing down
Terminal box	Aluminium alloy	<ul style="list-style-type: none"> - fitted with a steel standard terminal board (brass as an optional extra) - terminal box fitted with threaded plugs, supplied without cable gland (cable gland as an option) - 1 earth terminal in all terminal boxes - fixation system cover with captive screws

Enclosed three-phase asynchronous motors driven by electronic drive LSMV



Mounting positions

Foot mounted motors

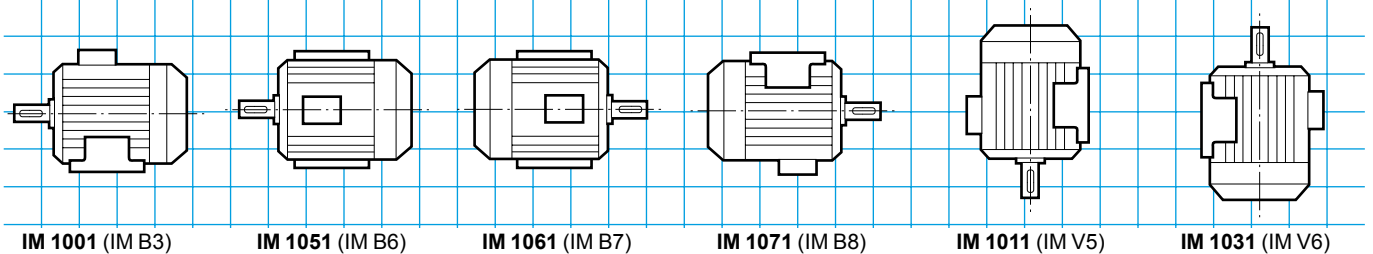

IM 1001 (IM B3)

IM 1051 (IM B6)

IM 1061 (IM B7)

IM 1071 (IM B8)

IM 1011 (IM V5)

IM 1031 (IM V6)

(FF) plain hole flange mounted motors

- Possible position IM 3001 (IM B5) up to 225 frame size inclusive

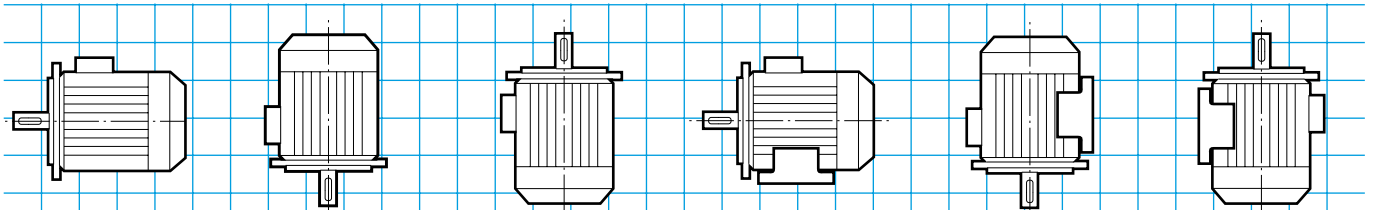

IM 3001 (IM B5)

IM 3011 (IM V1)

IM 3031 (IM V3)

IM 2001 (IM B35)

IM 2011 (IM V15)

IM 2031 (IM V36)

(FT) tapped hole flange mounted motors

- Possible positions up to 132 frame size included

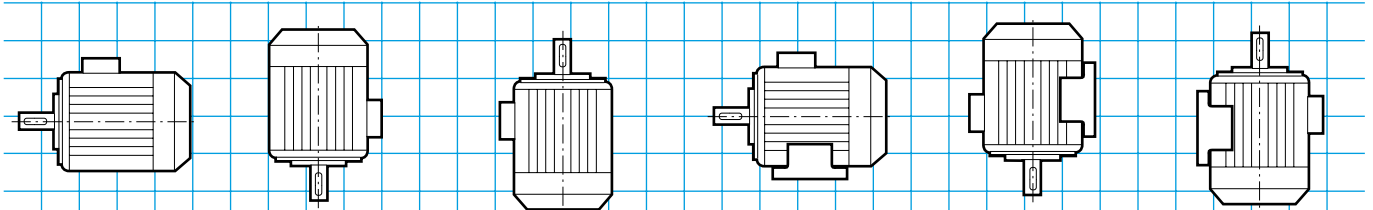

IM 3601 (IM B14)

IM 3611 (IM V18)

IM 3631 (IM V19)

IM 2101 (IM B34)

IM 2111 (IM V58)

IM 2131 (IM V69)

Motors without frontal bearing

Note: plated protection (IP) of motors IM B9 and IM B15 is ensured when mounting the motor by the customer.

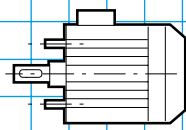

IM 9101 (IM B9)

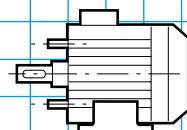

IM 1201 (IM B15)

Position of the terminal box
in relation to the motor shaft end

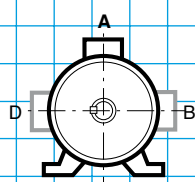

A: standard

Position of the cable gland
in relation to the motor shaft end

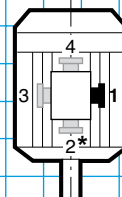

1: standard

* Position 2 not recommended and not feasible
on plain holes flange standard motor (FF)

Enclosed three-phase asynchronous motors driven by electronic drive LSMV



Adaptation possibilities

Leroy-Somer offers, for use with LSMV enclosed three-phase asynchronous motors, many options which meet the needs of highly diverse applications. They are described below and in the chapters relating to the gearboxes and to variable speed.

For other variants or any special adaptation, consult the technical specialists at Leroy-Somer.

The LSMV 3-phase asynchronous motors may be associated to:

- gearboxes
- electronic variable speed drive

The options:

- drip cover
- forced ventilation
- second shaft end
- encoder
- rest control brakes: FCR brake, FCPL brake, BK parking brake
- thermal protections
- non standard flanges

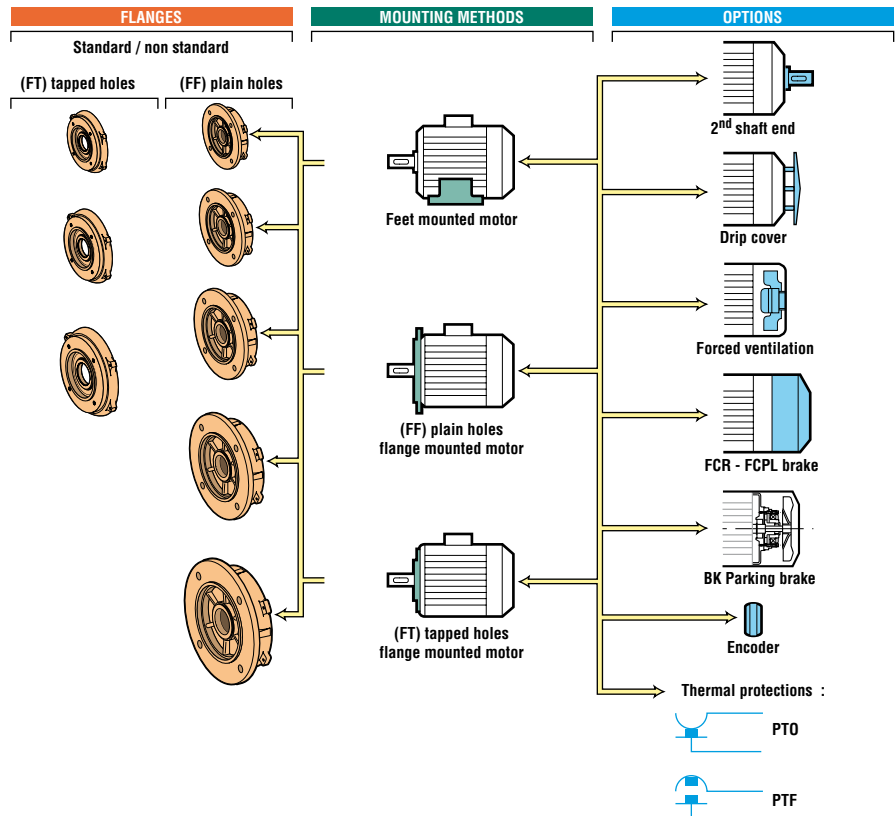

Designation / Codification

4P 1500 min ⁻¹	LSMV	100	LR	2.2 kW	LS2 / IE2	IM 1001 (IM B3)	230 / 400 V	50 Hz	IP 55
Speed polarity	Motor type	IEC 60072-1 frame size	Housing designation and builder index	Rated power	Efficiency class	IEC 60034-7 mounting position	Power supply voltage	Power supply frequency	IEC 60034-5 protection

Codification example:

LSMV motor, 1500 min⁻¹, 2.2 kW
IM 1001 (IM B3), 230 / 400 V

Designation	Code
4P LSMV 100 LR 2.2 kW LS2/IE2	
IM 1001 (IM B3) 230 / 400 V	4750103

The table above is an example.

It allows the creation of the designation for the required product.

This designation corresponds to a product code.

The product codes that are present in the selection grids can be used directly.

They simplify the ordering process.

The codification table is incorporated in the price list with the designations list.

Enclosed three-phase asynchronous motors driven by electronic drive LSMV



Selection

CHOICE OF MOTOR TYPE AND DRIVE

The integration of the speed variation in a kinematics chain leads to certain constraints divided in two categories:
- needs to application
example: centrifugal machines

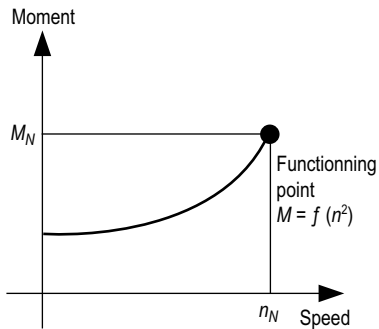

- imperatives due to the association motor / electronic drive: noise, harmonic presence, etc.

LEROY-SOMER proposes:

- **LSES standard range:**
 - motors according to IEC standards
 - IP 55
 - insulation class F
 - thermal reserve > 20°C
 - balancing level A

Electrical and mechanical construction of the motors respond perfectly to standard applications: ventilation, pump, etc.

- **LSMV range:**
 - motors according to IEC standards
 - IP 55
 - insulation class F
 - improved thermal reserve with increased overtorque capacity
 - balancing level B for frame size ≤ 132

- protection thermal probes (CTP 150°C)
- terminal box in aluminium
- metal ventilation cover

Thanks to a particular conception of the active magnetic side, these motors can responds to most restricting applications: low speed rated torque, even zero.

• adapted motors construction at very high speed:

From a drive adapted tuning with constant U/F, these motors can give a proportional power to the speed.
These motors make the objet of particular offers.

Features thermal torque / speed of LSES and LSMV ranges

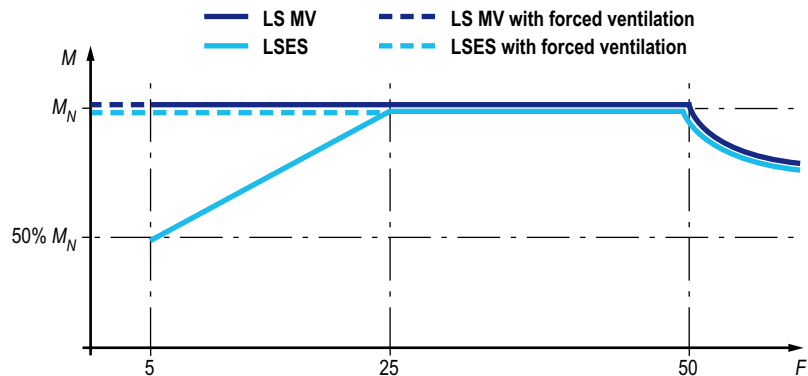

CHOICE OF POLARITY

Polarity is one of the main criteria. In fact, as shown in the graph below, the sharing-out of the torques differs depending on the polarity of the used motor. Thus, for use only in low speed, choose a 6 poles motor.

The opposite, for a functioning at high speed 2 poles motor will be selected.

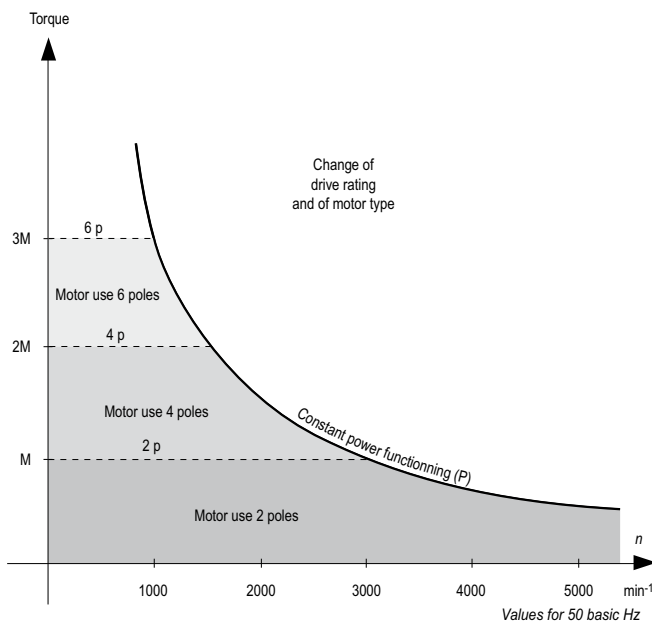

CHOICE OF OPTIONS

Depending to the speed applications and controllers, many accessories are necessary:

Forced ventilation:

- for operation in low speed ($< n_N/2^*$ for LSES motor and $< n_N/10^*$ for LSMV) in continuous duty,
- for operation in high speed (particular study).

Encoder:

- for operation on drive with flow vectorial control,
- for lower speeds $n_N/10^*$,
- for a speed precision required necessary for some of controls.

* n_N = rated speed

Brake:

Brake	Frame size
Type BK	80 to 132
Type FCR	80 to 132
Type FCPL	160 to 250

Enclosed three-phase asynchronous motors driven by electronic drive LSMV

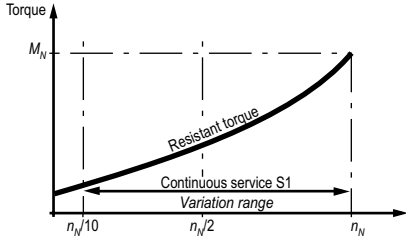
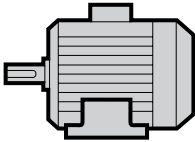
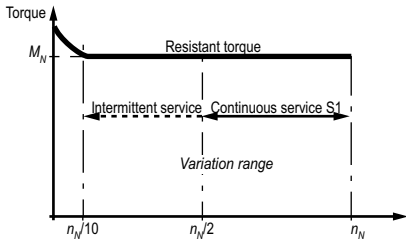
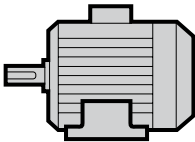
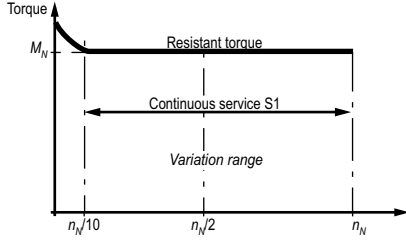
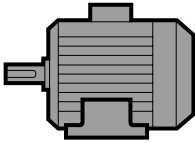
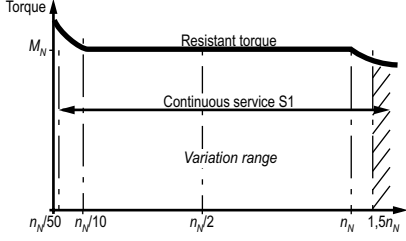
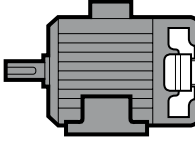
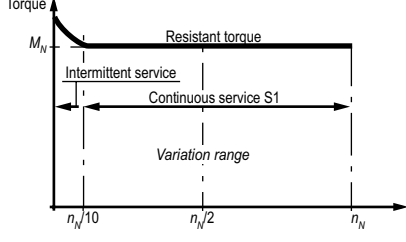
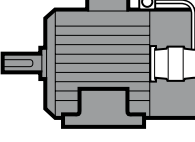
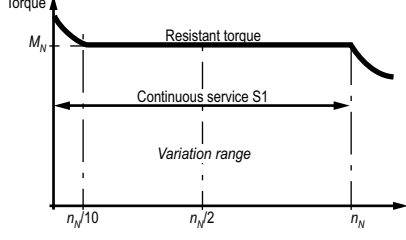
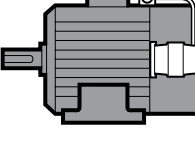

Selection

<p>Centrifugal use or quadratic resistant torque</p>	 <p>n_N = rated speed</p> <p>Use on resistant torques depending on the speed for $f < 50$ Hz</p>	 <p>LSES motor ≤ 22 kW Derated motor ≥ 30 kW</p>
<p>General use or constant resistant torque</p>	 <p>Use on a speed range from 25 to 50 Hz (1 to 2) in continuous service (S1)</p>	 <p>LSES motor ≤ 22 kW Derated motor ≥ 30 kW</p>
	 <p>Use on a speed range from 5 to 50 Hz (1 to 10) in continuous service (S1)</p>	 <p>LSMV motor</p>
	 <p>Use on the extreme speed ranges: < 5 Hz and > 70 Hz</p>	 <p>LSMV motor with forced ventilation</p>
	 <p>Use: - from 0 to 50 Hz with a range from 0 to 5 Hz in intermittent service - with great speed and torque dynamics accuracy</p>	 <p>LSMV motor with encoder</p>
	 <p>Use: - from 0 to 50 Hz with a range from 0 to 5 Hz in continuous service - with great speed and torque dynamics accuracy</p>	 <p>LSMV motor with encoder and forced ventilation</p>

This guide is general. Performances of the variable speed drives are presented in particular tables.

Enclosed three-phase asynchronous motors driven by electronic drive LSMV



Selection

IP 55 - 50 Hz - Class F - Δ T 80 K - 230 V Δ / 400 V Y - S1 - Class IE2

2
poles
120 to 6000 min⁻¹

IE2

Type	Rated power	Rated speed	Rated torque	Rated current	Power factor	Efficiency IEC 60034-2-1 2007			Maximum torque/ Rated torque	Moment of inertia	Weight	Noise
	P_N kW	N_N min ⁻¹	M_N N.m	$I_{N(400V)}$ A	$\cos \varphi$ 4/4	η 4/4	3/4	2/4	M_M/M_n	J kg.m ²	IM B3 kg	LP db(A)
LSMV 80 L	0.75	2859	2.51	1.68	0.85	78.6	78.8	77.2	3.0	0.00840	9.5	61
LSMV 80 L	1.1	2845	3.7	2.34	0.85	79.7	80.9	79.2	3.4	0.00095	10.7	61
LSMV 90 S	1.5	2860	4.91	3.16	0.84	81.7	82.3	80.6	4.5	0.00149	12.9	64
LSMV 90 L	2.2	2870	7.13	4.46	0.84	83.7	83.7	81.6	4.1	0.00197	16.1	64
LSMV 100 L	3	2870	10.0	5.87	0.87	84.8	85.6	84.5	4.0	0.00267	22.2	66
LSMV 112 MR	4	2864	13.4	7.9	0.85	86.1	86.8	86.0	3.7	0.00323	26.5	66
LSMV 132 S	5.5	2923	17.9	9.98	0.90	88.1	88.9	88.4	3.5	0.00881	35	72
LSMV 132 SU	7.5	2923	24.1	13.3	0.91	88.1	88.9	88.9	3.1	0.01096	41	72
LSMV 132 M	9	2925	29.2	17.7	0.82	89.5	89.8	89.2	3.6	0.01640	50	72
LSMV 160 MP	11	2927	35.9	21.2	0.84	89.6	90.1	89.4	4.6	0.01940	63	72
LSMV 160 MR	15	2924	49.2	27.2	0.89	90.4	91.4	91.3	3.8	0.02560	75	72
LSMV 160 L	18.5	2944	60.1	32.9	0.89	91.5	91.9	91.4	3.0	0.05000	101	72
LSMV 180 MT	22	2938	71.9	38.9	0.89	91.8	92.3	91.9	3.2	0.06000	105	69
LSMV 200 LR	30	2952	97.3	51.2	0.92	92.3	92.7	92.1	3.5	0.10000	155	77
LSMV 200 L	37	2943	119	64.8	0.89	92.9	93.1	92.7	2.5	0.12000	182	73
LSMV 225 MT	45	2953	145	79.5	0.88	93.1	93.4	92.8	3.4	0.14000	203	73

Enclosed three-phase asynchronous motors driven by electronic drive LSMV



Selection

IP 55 - 50 Hz - Class F - Δ T 80 K - 230 V Δ / 400 V Y - S1 - Class IE2

4
poles
150 to 3000 min⁻¹

IE2

Type	Rated power	Rated speed	Rated torque	Rated current	Power factor	Efficiency IEC 60034-2-1 2007			Maximum torque/ Rated torque	Moment of inertia	Weight	Noise
	P_N kW	N_N min ⁻¹	M_N N.m	$I_{N(400V)}$ A	$\cos \varphi$ 4/4	η 4/4	3/4	2/4	M_M/M_n	J kg.m ²	IM B3 kg	LP db(A)
LSMV 80 LG	0.75	1445	4.9	1.7	0.71	79.7	79.7	76.8	2.6	0.00265	11.7	47
LSMV 90 SL	1.1	1455	6.7	2.2	0.81	83.5	84.2	83.1	3.2	0.00418	17.1	48
LSMV 90 LU	1.5	1455	9.4	3.1	0.80	84.7	85.3	83.7	4.0	0.00488	20.4	48
LSMV 100 LR	2.2	1455	14.0	4.5	0.79	85.9	86.4	84.9	3.8	0.00426	24.9	48
LSMV 100 LG	3	1460	19.8	6.2	0.81	86.9	88.1	87.9	3.4	0.01080	32.4	48
LSMV 112 MU	4	1465	26.0	8.4	0.78	87.5	88.2	87.5	3.8	0.01373	40.4	49
LSMV 132 SM	5.5	1455	35.8	10.5	0.86	87.9	88.6	88.0	3.8	0.02257	60.1	62
LSMV 132 M	7.5	1455	48.8	14.2	0.85	89.2	90.0	89.9	4.2	0.02722	70.2	62
LSMV 132 MU	9	1465	58.7	18.2	0.80	89.3	89.3	87.8	5.3	0.02928	70.2	62
LSMV 160 MR	11	1460	71.4	21.3	0.83	89.9	90.7	90.4	4.1	0.03529	78.2	62
LSMV 160 LUR	15	1466	97.6	27.4	0.86	92.0	92.4	92.0	3.6	0.0955	103	62
LSMV 180 M	18.5	1469	120	35.2	0.82	92.4	92.6	91.8	3.0	0.1229	136	64
LSMV 180 LUR	22	1470	142	40.2	0.85	92.1	92.6	92.2	3.2	0.1451	155	64
LSMV 200 L	30	1474	194	55.9	0.83	93.4	93.8	93.4	2.6	0.2365	200	64
LSMV 1125 SR	37	1477	239	68.0	0.84	93.7	94.4	94.5	2.9	0.2885	235	64
LSMV 225 MG	45	1485	289	82.0	0.83	94.1	94.3	94.2	2.9	0.6341	320	64
LSMV 250 ME	55	1484	355	100	0.84	94.5	94.9	94.6	3.0	0.732	340	66
LSMV 280 SD	75	1485	482	136	0.84	94.9	94.9	94.2	3.0	0.9612	495	69
LSMV 280 MK	90	1489	578	161	0.85	94.9	94.7	93.7	3.1	2.3099	655	69
LSMV 315 SP	110	1490	705	196	0.85	95.2	94.8	93.5	3.6	3.2642	845	74
LSMV 315 MR	132	1489	847	238	0.84	95.3	94.9	93.8	3.8	2.7844	750	70

Enclosed three-phase asynchronous motors driven by electronic drive LSMV



Selection

IP 55 - 50 Hz - Class F - Δ T 80 K - 230 V Δ / 400 V Y - S1 - Class IE2

6
poles
60 to 2000 min⁻¹

IE2

Type	Rated power	Rated speed	Rated torque	Rated current	Power factor	Efficiency IEC 60034-2-1 2007			Maximum torque/ Rated torque	Moment of inertia	Weight	Noise
	P_N kW	N_N min ⁻¹	M_N N.m	$I_{N(400V)}$ A	$\cos \varphi$ 4/4	η 4/4	3/4	2/4	M_M/M_n	J kg.m ²	IM B3 kg	LP db(A)
LSMV 90 S	0.75	953	7.6	2.1	0.68	76.6	77.1	74.4	2.1	0.00319	14	51
LSMV 90 L	1.1	955	11.0	3.0	0.67	79.1	79.5	77.4	3.1	0.0044	16.6	51
LSMV 100 L	1.5	957	14.9	4.0	0.66	80.5	81.1	79.0	2.2	0.00587	22.1	50
LSMV 112 MG	2.2	957	20.9	5.0	0.73	82.2	83.3	82.0	2.4	0.011	28	51
LSMV 132 S	3	962	29.1	7.0	0.72	83.8	84.5	83.1	3.1	0.0154	38	55
LSMV 132 M	4	963	39.4	9.0	0.75	85.2	86.7	86.4	2.6	0.0249	48	55
LSMV 132 MU	5.5	963	55.0	12.9	0.72	86.4	87.4	86.9	2.8	0.0364	63	55

Enclosed three-phase asynchronous motors driven by electronic drive LSMV



Dimensions

Dimensions of enclosed 3-phase asynchronous LSMV motors - IP 55 without options
Cage rotor

Dimensions in millimetres

- shaft end

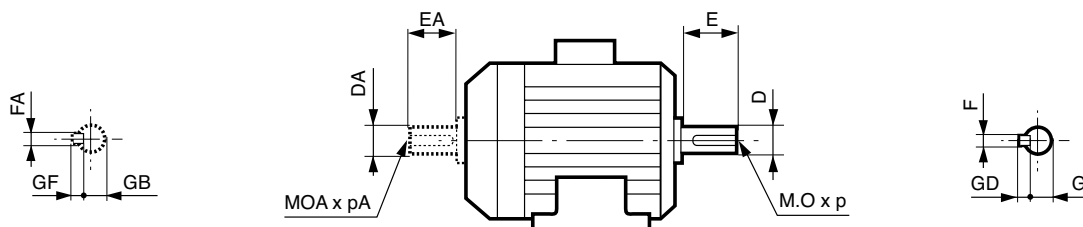

Type	Main shaft end													
	4 and 6 poles							2 poles						
	F	GD	D	G	E	O	p	F	GD	D	G	E	O	p
LSMV 71	5	5	14j6	11	30	5	15	5	5	14j6	11	30	5	15
LSMV 80 L/LG	6	6	19j6	15.5	40	6	16	6	6	19j6	15.5	40	6	16
LSMV 90 S/L/SL	8	7	24j6	20	50	8	19	8	7	24j6	20	50	8	19
LSMV 100 L/LR/LG	8	7	28j6	24	60	10	22	8	7	28j6	24	60	10	22
LSMV 112 MR/MG/MU	8	7	28j6	24	60	10	22	8	7	28j6	24	60	10	22
LSMV 132 S/SM/M/SU/MU	10	8	38k6	33	80	12	28	10	8	38k6	33	80	12	28
LSMV 160 MR/MP/LUR	12	8	42k6	37	110	16	36							
LSMV 180 M/LUR	14	9	48k6	42.5	110	16	36							
LSMV 200 L	16	10	55m6	49	110	20	42							
LSMV 225 SR/MR	18	11	60m6	53	140	20	42							
LSMV 250 ME	18	11	65m6	58	140	20	42							
LSMV 280 SD/MK	20	12	75m6	67.5	140	20	42							
LSMV 315 SP/MR	22	14	80m6	71	170	20	42							

Type	Secondary shaft end													
	4 and 6 poles							2 poles						
	FA	GF	DA	GB	EA	OA	pA	FA	GF	DA	GB	EA	OA	pA
LSMV 71	5	5	14j6	11	30	5	15	5	5	14j6	11	30	5	15
LSMV 80 L/LG	5	5	14j6	11	30	5	15	5	5	14j6	11	30	5	15
LSMV 90 S/L/SL	6	6	19j6	15.5	40	6	16	6	6	19j6	15.5	40	6	16
LSMV 100 L/LR/LG	8	7	24j6	20	50	8	19	8	7	24j6	20	50	8	19
LSMV 112 MR/MG/MU	8	7	24j6	20	50	8	19	8	7	24j6	20	50	8	19
LSMV 132 S/SM/M/SU/MU	8	7	28j6	24	60	10	22	8	7	28j6	24	60	10	22
LSMV 160 MR/MP	12	8	38k6	37	80	16	36							
LSMV 160 LUR	12	8	42k6	37	110	16	36							
LSMV 180 M/L/LU	14	9	48k6	42.5	110	16	36							
LSMV 200 LT/L	16	10	55m6	49	110	20	42							
LSMV 225 SR/MR/MG	18	11	60m6	53	140	20	42							
LSMV 250 ME	18	11	60m6	53	140	20	42							
LSMV 280 SD/SC/MC/MK	18	11	65m6	58	140	20	42							
LSMV 315 SP/MP/MR	22	14	80m6	71	170	20	42							

Enclosed three-phase asynchronous motors driven by electronic drive LSMV



Dimensions

Dimensions of enclosed 3-phase asynchronous LSMV motors - IP 55 without options
Cage rotor

Dimensions in millimetres

- feet mounting

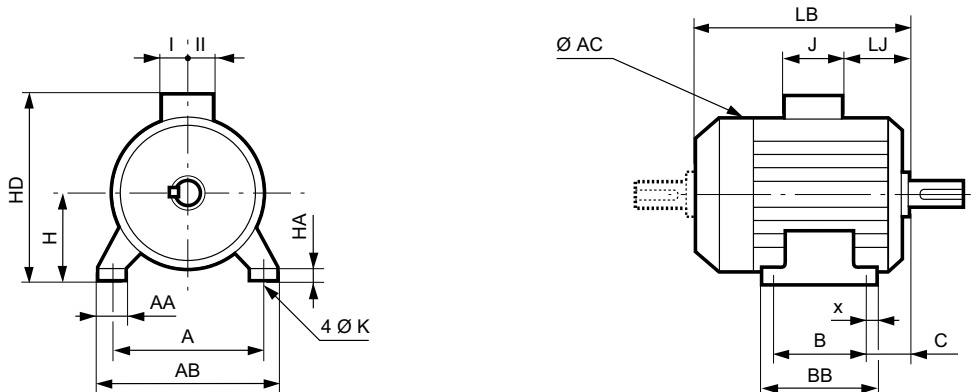

Type	Main dimensions																
	A	AB	B	BB	C	x	AA	K	HA	H	AC	HD	LB	LJ	J	I	II
LSMV 80 L	125	157	100	120	50	10	29	9	10	80	170	221	212	13.5	160	55	55
LSMV 80 LG	125	157	100	125	50	14	31	9	10	80	185	231	243	13.5	160	55	55
LSMV 90 S	140	172	100	120	56	10	37	10	11	90	190	241	212	13.5	160	55	55
LSMV 90 SL	140	172	125	162	56	28	39	10	11	90	190	241	236	13.5	160	55	55
LSMV 90 L	140	172	125	162	56	28	39	10	11	90	190	241	239	13.5	160	55	55
LSMV 90 LU	140	172	125	162	56	28	39	10	11	90	190	241	265	13.5	160	55	55
LSMV 100 L	160	196	140	165	63	12	40	12	13	100	200	256	288	14.5	160	55	55
LSMV 100 LR	160	196	140	165	63	12	40	12	13	100	200	256	314	14.5	160	55	55
LSMV 100 LG	160	196	140	170	63	11	49	12	13	100	230	265	305	23.5	160	55	55
LSMV 112 MR	190	220	140	165	70	13	45	12	14	112	200	268	314	14.5	160	55	55
LSMV 112 MG	190	220	140	165	70	12	52	12	14	112	235	277	305	23.5	160	55	55
LSMV 112 MU	190	220	140	165	70	12	52	12	14	112	235	277	333	23.5	160	55	55
LSMV 132 S	216	250	140	170	89	16	42	12	16	132	220	300	350	40.5	160	55	55
LSMV 132 SU	216	250	140	170	89	16	42	12	16	132	220	300	377	40.5	160	55	55
LSMV 132 SM	216	250	178	208	114	15	50	12	15	132	265	318	410	50	160	55	55
LSMV 132 M	216	250	178	208	89	15	50	12	15	132	265	318	385	25	160	55	55
LSMV 132 MU	216	250	178	208	89	15	50	12	15	132	265	318	412	25	160	55	55
LSMV 160 MP	254	294	210	294	108	20	64	14	25	160	264	346	468	66.5	160	55	55
LSMV 160 MR	254	294	210	294	108	20	64	14	25	160	264	346	495	66.5	160	55	55
LSMV 160 LUR	254	294	254	294	108	20	60	14.5	25	160	312	395	510	42.75	135	88	64
LSMV 180 M	279	339	241	329	115	25	86	14.5	25	180	350	456	546	94.5	186	112	98
LSMV 180 LUR	279	339	279	329	121	25	86	14.5	25	180	350	436	614	63.5	186	112	98
LSMV 200 L	318	388	305	375	133	35	103	18.5	36	200	390	476	621	77	186	112	98
LSMV 225 SR	356	431	286	386	149	50	127	18.5	36	225	390	535	675.5	61	231	119	142
LSMV 225 MG	356	420	311	375	142.5	30	65	18.5	30	225	479	631	803.5	61	292	151	181
LSMV 250 ME	406	470	349	420	168	35	90	24	36	250	479	656	810	67.5	292	151	181
LSMV 280 SD	457	520	368	478	190	35	90	24	35	280	479	686	870	67.5	292	151	181
LSMV 280 MK	457	533	419	495	190	40	85	24	35	280	586	765	921	98.5	292	151	181
LSMV 315 SP	508	594	406	537	216	40	114	28	70	315	586	867	1947	61.5	418	180	235
LSMV 315 MR	508	594	457	537	216	40	114	28	70	315	586	867	1017	61.5	418	180	235

Enclosed three-phase asynchronous motors driven by electronic drive LSMV



Dimensions

Dimensions of enclosed 3-phase asynchronous LSMV motors - IP 55 without options Cage rotor

Dimensions in millimetres

– (FF) foot and plain holes flange

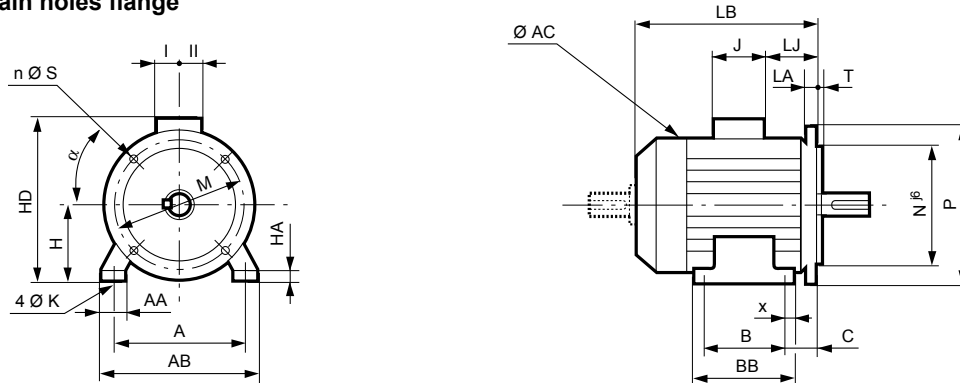

Type	Main dimensions																	
	A	AB	B	BB	C	x	AA	K	HA	H	AC	HD	LB	LJ	J	I	II	Symb
LSMV 80 L	125	157	100	120	50	10	29	9	10	80	170	221	212	14.5	160	55	55	FF 165
LSMV 80 LG	125	157	100	125	70	14	31	9	10	80	185	231	263	34.5	160	55	55	FF 165
LSMV 90 S	140	172	100	120	76	10	37	10	11	90	190	241	232	33.5	160	55	55	FF 165
LSMV 90 SL	140	172	125	162	76	28	39	10	11	90	190	241	259	33.5	160	55	55	FF 165
LSMV 90 L	140	172	125	162	76	28	39	10	11	90	190	241	259	33.5	160	55	55	FF 165
LSMV 90 LU	140	172	125	162	76	28	39	10	11	90	190	241	285	33.5	160	55	55	FF 165
LSMV 100 L	160	196	140	165	63	12	40	12	13	100	200	256	288	14.5	160	55	55	FF 215
LSMV 100 LR	160	196	140	165	63	12	40	12	13	100	200	256	314	14.5	160	55	55	FF 215
LSMV 100 LG	160	196	140	170	63	11	49	12	13	100	230	265	305	13.5	160	55	55	FF 215
LSMV 112 MR	190	220	140	165	70	13	45	12	14	112	200	268	314	14.5	160	55	55	FF 215
LSMV 112 MG	190	220	140	165	69	12	52	12	14	112	235	277	305	23.5	160	55	55	FF 215
LSMV 112 MU	190	220	140	165	70	12	52	12	14	112	235	277	333	23.5	160	55	55	FF 215
LSMV 132 S	216	250	140	170	89	16	42	12	16	132	220	300	350	40.5	160	55	55	FF 265
LSMV 132 SU	216	250	140	170	89	16	42	12	16	132	220	300	377	40.5	160	55	55	FF 265
LSMV 132 SM	216	250	178	208	89	15	50	12	15	132	265	318	410	50	160	55	55	FF 265
LSMV 132 M	216	250	178	208	114	15	50	12	15	132	265	318	385	25	160	55	55	FF 265
LSMV 132 MU	216	250	178	208	89	15	50	12	15	132	265	318	412	25	160	55	55	FF 265
LSMV 160 MP	254	294	210	294	108	20	64	14	25	160	264	346	468	66.5	160	55	55	FF 300
LSMV 160 MR	254	294	210	294	108	20	64	14	25	160	264	346	495	66.5	160	55	55	FF 300
LSMV 160 LUR	254	294	254	294	108	20	60	14.5	25	160	312	395	510	42.75	135	88	64	FF 300
LSMV 180 M	279	339	241	329	121	25	86	14.5	25	180	350	456	546	94.5	186	112	98	FF 300
LSMV 180 LUR	279	339	279	329	115	25	86	14.5	25	180	350	436	614	63.5	186	112	98	FF 300
LSMV 200 L	318	388	305	375	133	35	103	18.5	36	200	390	476	621	77	186	112	98	FF 350
LSMV 225 SR	356	431	286	386	142.5	50	127	18.5	36	225	390	535	675.5	61	231	119	142	FF 400
LSMV 225 MG	356	420	311	375	149	30	65	18.5	30	225	479	631	803.5	61	292	151	181	FF 400
LSMV 250 ME	406	470	349	420	168	35	90	24	36	250	479	656	810	67.5	292	151	181	FF 500
LSMV 280 SD	457	520	368	478	168	35	90	24	35	280	479	686	870	67.5	292	151	181	FF 500
LSMV 280 MK	457	533	419	495	190	40	85	24	35	280	586	765	921	98.5	292	151	181	FF 500
LSMV 315 SP	508	594	406	537	216	40	114	28	70	315	586	867	947	61.5	418	180	236	FF 600
LSMV 315 MR	508	594	457	537	216	40	114	28	70	315	586	867	1017	61.5	418	180	236	FF 600

Enclosed three-phase asynchronous motors driven by electronic drive LSMV



Dimensions

Dimensions of enclosed 3-phase asynchronous LSMV motors - IP 55 without options Cage rotor

Dimensions in millimetres

– (FF) plain holes flange mounted

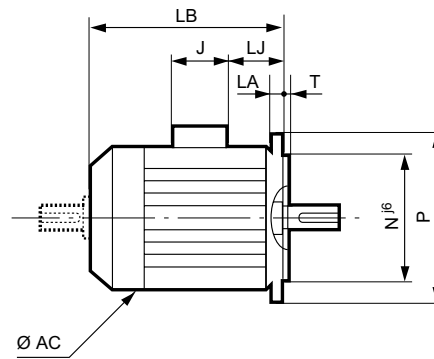
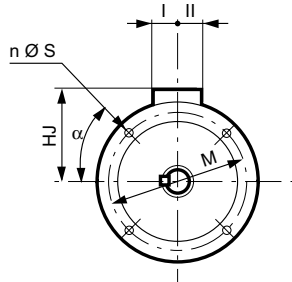

IEC symbol	Flange dimensions							
	M	N	P	T	n	α°	S	LA
FF 165	165	130	200	3.5	4	45	12	10
FF 165	165	130	200	3.5	4	45	12	10
FF 165	165	130	200	3.5	4	45	12	10
FF 165	165	130	200	3.5	4	45	12	10
FF 165	165	130	200	3.5	4	45	12	10
FF 215	215	180	250	4	4	45	14.5	12
FF 215	215	180	250	4	4	45	14.5	12
FF 215	215	180	250	4	4	45	14.5	12
FF 215	215	180	250	4	4	45	14.5	11
FF 215	215	180	250	4	4	45	14.5	11
FF 215	215	180	250	4	4	45	14.5	11
FF 265	265	230	300	4	4	45	14.5	12
FF 265	265	230	300	4	4	45	14.5	12
FF 265	265	230	300	4	4	45	14.5	12
FF 265	265	230	300	4	4	45	14.5	12
FF 265	265	230	300	4	4	45	14.5	12
FF 300	300	250	350	5	4	45	18.5	14
FF 300	300	250	350	5	4	45	18.5	14
FF 300	300	250	350	5	4	45	18.5	14
FF 300	300	250	350	5	4	45	18.5	14
FF 300	300	250	350	5	4	45	18.5	14
FF 350	350	300	400	5	4	45	18.5	15
FF 400	400	350	450	5	8	22.5	18.5	16
FF 400	400	350	450	5	8	22.5	18.5	16
FF 500	500	450	550	5	8	22.5	18.5	18
FF 500	500	450	550	5	8	22.5	18.5	18
FF 500	500	450	550	5	8	22.5	18.5	18
FF 600	600	550	660	6	8	22.5	24	22
FF 600	600	550	660	6	8	22.5	24	22

Type	Main dimensions						
	AC	LB	HJ	LJ	J	I	II
LSMV 80 L	170	212	141	14.5	160	55	55
LSMV 80 LG	185	263	151	34.5	160	55	55
LSMV 90 S	190	232	151	33.5	160	55	55
LSMV 90 SL	190	259	151	33.5	160	55	55
LSMV 90 L	190	259	151	33.5	160	55	55
LSMV 90 LU	190	285	151	33.5	160	55	55
LSMV 100 L	200	288	156	14.5	160	55	55
LSMV 100 LR	200	314	156	14.5	160	55	55
LSMV 100 LG	230	305	165	13.5	160	55	55
LSMV 112 MR	200	314	156	14.5	160	55	55
LSMV 112 MG	235	305	165	23.5	160	55	55
LSMV 112 MU	235	333	165	23.5	160	55	55
LSMV 132 S	220	350	168	40.5	160	55	55
LSMV 132 SU	220	377	168	40.5	160	55	55
LSMV 132 SM	265	410	186	50	160	55	55
LSMV 132 M	265	385	186	25	160	55	55
LSMV 132 MU	265	412	186	25	160	55	55
LSMV 160 MP	264	468	186	66.5	160	55	55
LSMV 160 MR	264	495	186	66.5	160	55	55
LSMV 160 LUR	312	510	235	42.75	135	88	64
LSMV 180 M	350	546	276	94.5	186	112	98
LSMV 180 LUR	350	614	256	63.5	186	112	98
LSMV 200 L	390	621	276	77	186	112	98
LSMV 225 SR	390	675.5	310	61	231	119	142
LSMV 225 MG	479	803.5	406	61	292	151	181
LSMV 250 ME	479	810	406	67.5	292	151	181
LSMV 280 SD	479	870	406	67.5	292	151	181
LSMV 280 MK	586	921	466	98.5	292	151	181
LSMV 315 SP	586	947	555	61.5	418	180	235
LSMV 315 MR	586	1017	555	61.5	418	180	235

For use in IM 3001, for frame size ≥ 250 mm, consult us.
Shaft end dimensions identical to those of the foot mounted motors.

Enclosed three-phase asynchronous motors driven by electronic drive LSMV



Dimensions

Dimensions of enclosed 3-phase asynchronous LSMV motors - IP 55 without options
Cage rotor

Dimensions in millimetres

– (FT) foot and tapped holes flange mounted

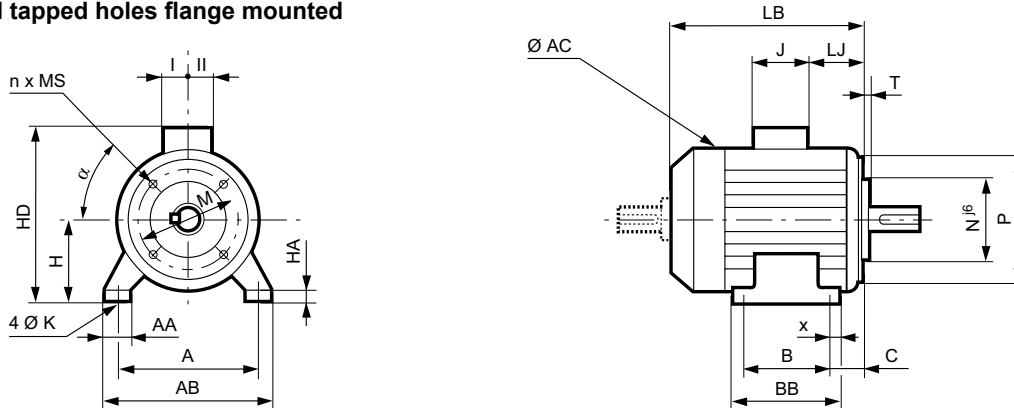

Type	Main dimensions																	Symb
	A	AB	B	BB	C	x	AA	K	HA	H	AC	HD	LB	LJ	J	I	II	
LSMV 80 L	125	157	100	120	50	10	29	9	10	80	170	221	212	13.5	160	55	55	FT 100
LSMV 80 LG	125	157	100	125	50	14	31	9	10	80	185	231	243	13.5	160	55	55	FT 100
LSMV 90 S	140	172	100	120	56	10	37	10	11	90	190	241	212	13.5	160	55	55	FT 115
LSMV 90 SL	140	172	125	162	56	28	39	10	11	90	190	241	239	13.5	160	55	55	FT 115
LSMV 90 L	140	172	125	162	56	28	39	10	11	90	190	241	239	13.5	160	55	55	FT 115
LSMV 90 LU	140	172	125	162	56	28	39	10	11	90	190	241	265	13.5	160	55	55	FT 115
LSMV 100 L	160	196	140	165	63	12	40	12	13	100	200	256	288	14.5	160	55	55	FT 130
LSMV 100 LR	160	196	140	165	63	12	40	12	13	100	200	256	314	14.5	160	55	55	FT 130
LSMV 100 LG	160	196	140	170	63	11	49	12	13	100	230	265	305	23.5	160	55	55	FT 130
LSMV 112 MR	190	220	140	165	70	13	45	12	14	112	200	268	314	14.5	160	55	55	FT 130
LSMV 112 MG	190	220	140	165	70	12	52	12	14	112	235	277	305	23.5	160	55	55	FT 130
LSMV 112 MU	190	220	140	165	70	12	52	12	14	112	235	277	333	23.5	160	55	55	FT 130
LSMV 132 S	216	250	140	170	89	16	42	12	16	132	220	300	350	40.5	160	55	55	FT 215
LSMV 132 SU	216	250	148	170	89	16	42	12	16	132	220	300	377	40.5	160	55	55	FT 215
LSMV 132 SM	216	250	178	208	114	15	50	12	15	132	265	318	410	50	160	55	55	FT 215
LSMV 132 M	216	250	178	208	89	15	50	12	15	132	265	318	385	25	160	55	55	FT 215
LSMV 132 MU	216	250	178	208	89	15	50	12	15	132	265	318	412	25	160	55	55	FT 215
LSMV 160 MP	254	294	210	294	108	20	64	14	25	160	264	346	468	66.5	160	55	55	FT 265
LSMV 160 MR	254	294	210	294	108	20	64	14	25	160	264	346	495	66.5	160	55	55	FT 265

Shaft end dimensions identical to those of the foot mounted motors.

Enclosed three-phase asynchronous motors driven by electronic drive LSMV



Dimensions

Dimensions of enclosed 3-phase asynchronous LSMV motors - IP 55 without options Cage rotor

Dimensions in millimetres

– (FT) tapped hole flange mounted

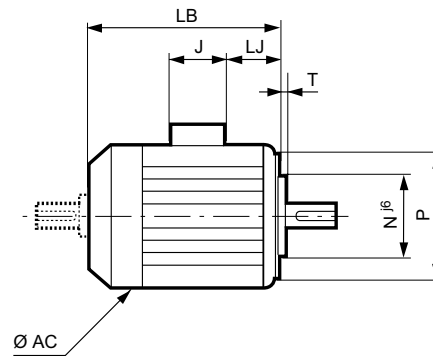
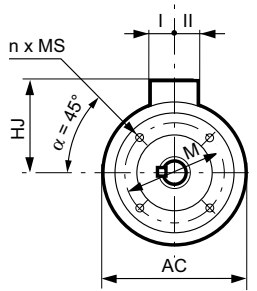

IEC symbol	Flange dimensions					
	M	N	P	T	n	MS
FT 100	100	80	120	3	4	M6
FT 100	100	80	120	3	4	M6
FT 115	115	95	140	3	4	M8
FT 115	115	95	140	3	4	M8
FT 115	115	95	140	3	4	M8
FT 115	115	95	140	3	4	M8
FT 130	130	110	160	3.5	4	M8
FT 130	130	110	160	3.5	4	M8
FT 130	130	110	160	3.5	4	M8
FT 130	130	110	160	3.5	4	M8
FT 130	130	110	160	3.5	4	M8
FT 130	130	110	160	3.5	4	M8
FT 215	215	180	250	4	4	M12
FT 215	215	180	250	4	4	M12
FT 215	215	180	250	4	4	M12
FT 215	215	180	250	4	4	M12
FT 215	215	180	250	4	4	M12
FT 215	215	180	250	4	4	M12
FT 215	215	180	250	4	4	M12

Type	Main dimensions						
	AC	LB	HJ	LJ	J	I	II
LSMV 80 L	170	212	141	13.5	160	55	55
LSMV 80 LG	185	243	151	13.5	160	55	55
LSMV 90 S	190	212	151	13.5	160	55	55
LSMV 90 SL	190	239	151	13.5	160	55	55
LSMV 90 L	190	239	151	13.5	160	55	55
LSMV 90 LU	190	265	151	13.5	160	55	55
LSMV 100 L	200	288	156	14.5	160	55	55
LSMV 100 LR	200	314	156	14.5	160	55	55
LSMV 100 LG	230	305	165	23.5	160	55	55
LSMV 112 MR	200	314	156	14.5	160	55	55
LSMV 112 MG	235	305	165	23.5	160	55	55
LSMV 112 MU	235	333	165	23.5	160	55	55
LSMV 132 S	220	350	168	40.5	160	55	55
LSMV 132 SU	220	377	168	40.5	160	55	55
LSMV 132 SM	265	410	186	50	160	55	55
LSMV 132 M	265	385	186	25	160	55	55
LSMV 132 MU	265	412	186	25	160	55	55
LSMV 160 MP	264	468	186	66.5	160	55	55
LSMV 160 MR	264	495	186	66.5	160	55	55

Shaft end dimensions identical to those of the foot mounted motors.

Enclosed three-phase asynchronous motors driven by electronic drive LSMV



Options

LSMV MOTORS WITH OPTIONS

Integration of LSMV motors within the process, sometimes requires their equipment with accessories that facilitate their use:

- forced ventilations for use of motors in low or high speed;
- parking brakes to maintain the shaft in stop positions without having to leave the motor switched on;

- emergency stop brakes to immobilize charges in case of fault of motor torque control or powered of due to supply mains fault;
- the encoder which, providing digital information, allows to refine speed and positioning control.

All these options can be combined.

Remarks:

- Without forced ventilation, possibility of overspeed with a balance level "B".
- Surveillance of motor temperature by incorporated probes a windings.